

LED Color Controller Kit

- The controller housing is made from Covestro/Samsung V0-rated flame-retardant PC material;
- Features a soft-start gradual dimming function for greater visual comfort;
- Featuring a streamlined design and magnetic attachment, it is powered by two AAA batteries ;
- Utilizes 2.4 GHz RF wireless transmission for stable signals and strong interference resistance;
- Equipped with a dedicated on/off button for one-touch lighting control;
- Quickly adjust color using the color temperature and color touch sliders;
- W and RGB brightness are controlled via dedicated buttons, supporting short presses to toggle on/off and long presses to adjust, ensuring intuitive and convenient operation;
- Pre-programmed with 2 scene modes for quick access, and custom scenes can be saved by holding down the button;
- A single controller can be paired with up to 10 remotes, and a single remote control can be used with multiple controllers;
- Supports synchronized dimming for controller groups.



Technical Specifications

C4 Remote Control

Area Control	Single zone
Dimming Type	RGBW
Wireless Type	RF 2.4GHz
Power Supply	3Vdc (AAA batteries × 2) Batteries must be purchased separately.
Standby Current	< 5uA
Operating Temperature	-25°C~50°C
Product Weight	Remote control: 62 g; Mount: 12 g
Dimensions	Remote control: L150 × W48 × H15.5 mm; Mount: L85 × W35 × H20 mm

P4 Controller

Input Voltage	12-48Vdc
Output Voltage	12-48Vdc
Wireless Type	RF 2.4GHz
Channel	4 CH
Load Current	Max. 15A
Load Power	180W@12V 288W@24V 360W@36V 480W@48V
Operating Temperature	-25°C~50°C
Protection	OCP、OTP、SCP、RCP
Product Weight	46g±5g
Dimensions	L91×W37×H21(mm)



RoHS



Dimensions

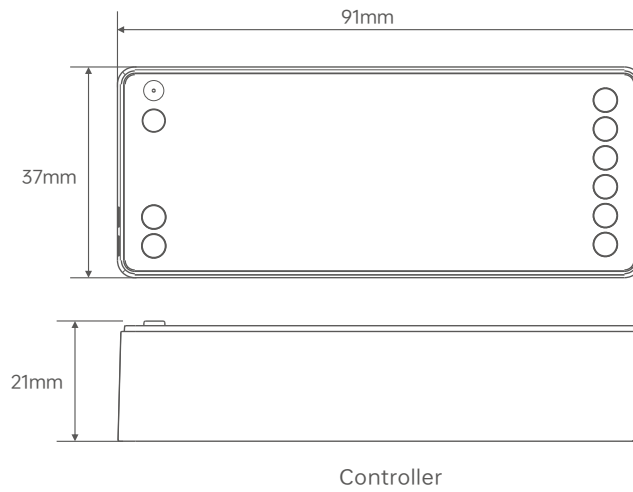
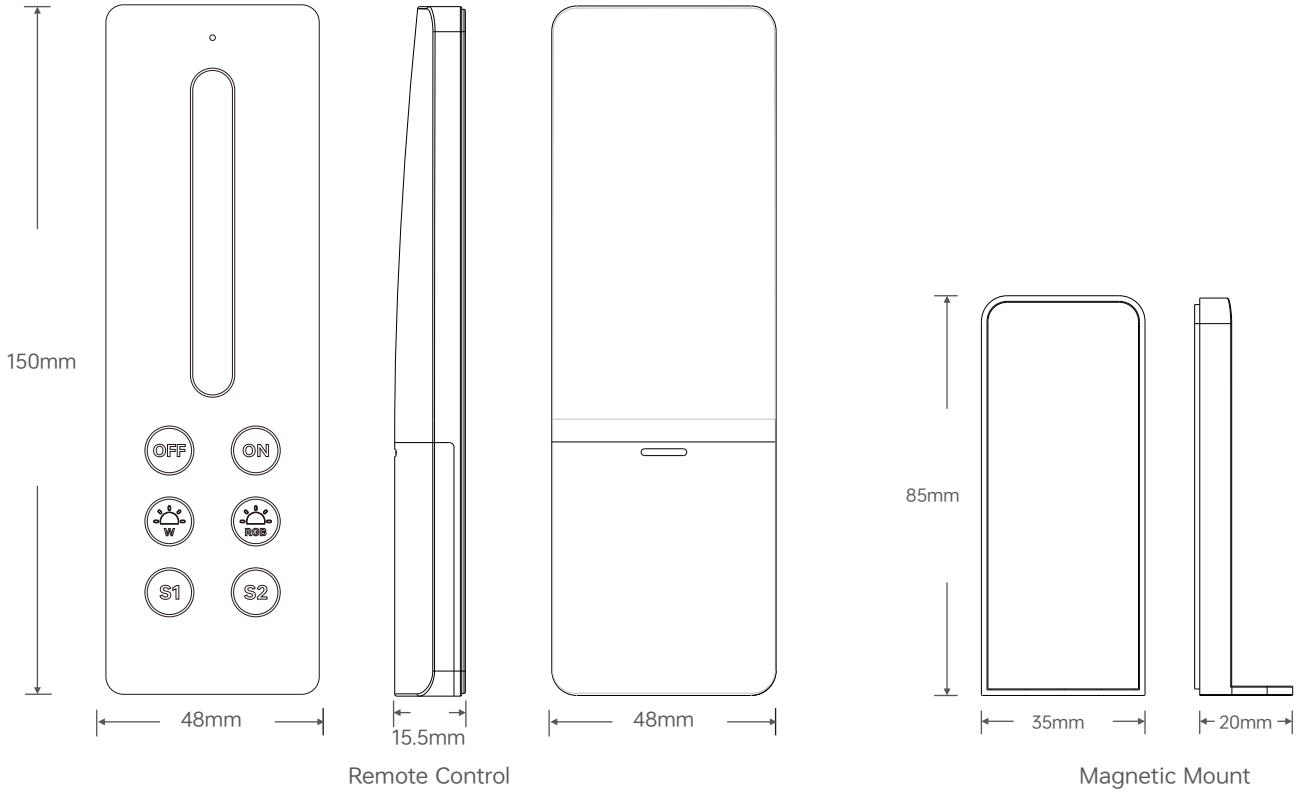

Product Installation

- ① Open the battery compartment on the remote control and insert two AAA batteries, making sure to insert them with the correct polarity.
- ② Peel off the protective film from the included double-sided tape, attach the magnetic mount to the wall, and press firmly to secure it (let it sit for 24 hours to ensure a secure bond before placing the remote control on it to prevent it from falling off).
- ③ Attach the remote control to the magnetic mount to complete the installation.

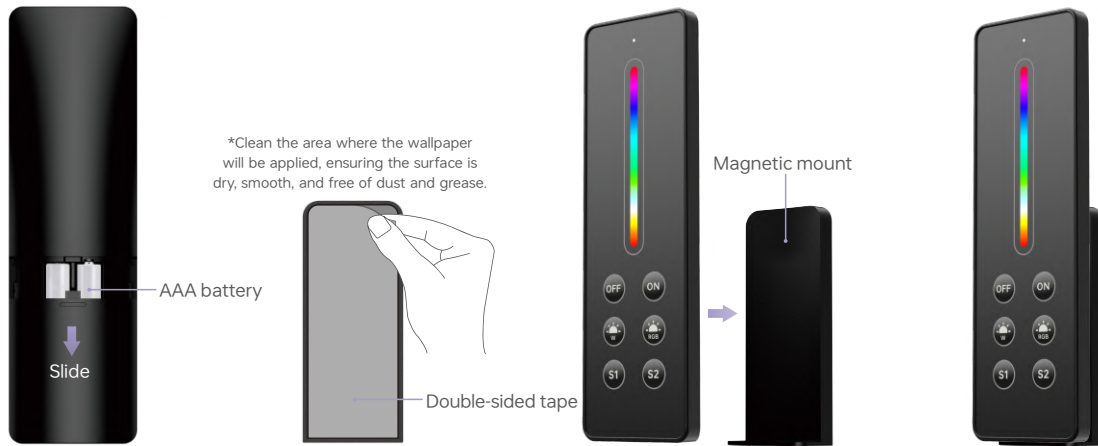

Feature Description

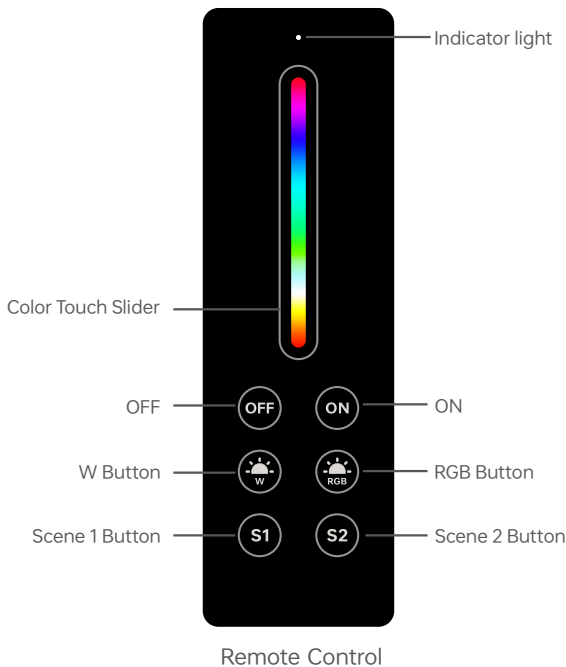

ON Button: Press briefly to turn on; press and hold for 2 seconds to pair.

OFF Button: Press briefly to turn off.

Color Touch Slider: Touch to change the RGB color of the lights.

W Button: Press briefly to toggle the W channel; press and hold to adjust the W brightness (stepless dimming).

RGB Button: Press briefly to toggle the RGB channel; press and hold to adjust RGB brightness (stepless dimming).

Scene Button: Press briefly to recall a scene; press and hold for 2 seconds to save the current lighting state to a scene, and the indicator light will flash red twice.

Indicator Light: The indicator light changes in sync with adjustments to color and brightness.

Note:

① If the indicator light on the remote control does not light up when a button is pressed, the batteries may be dead. Please replace the batteries promptly.

② If no buttons are pressed for 6 seconds, the remote control will enter sleep mode. Press any button to wake it up.

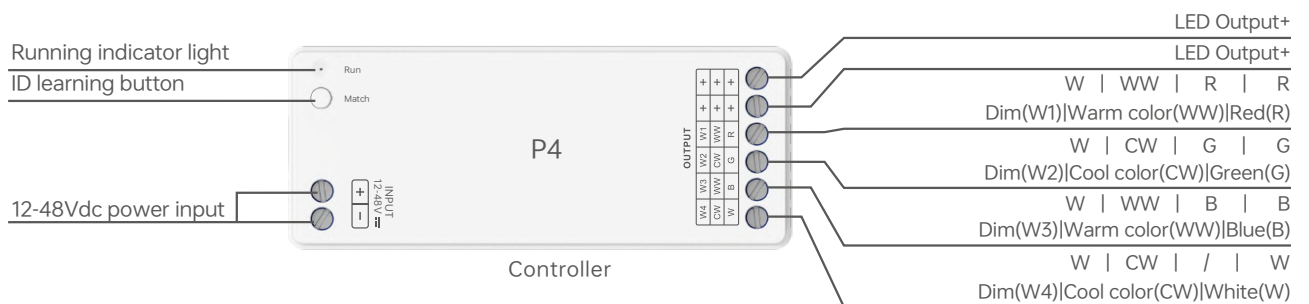

Wiring Diagram

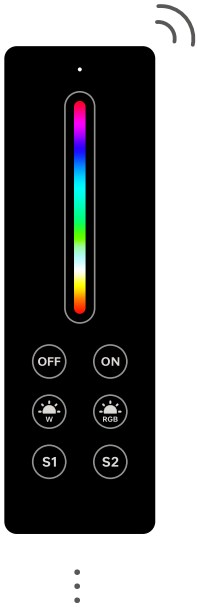

*Can be paired with up to 10 remote controls

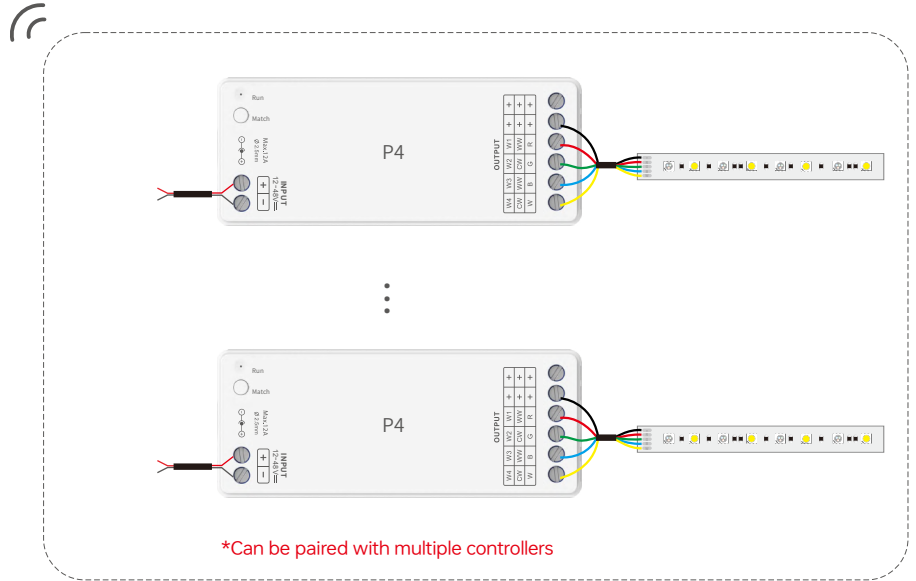

Installation Precautions

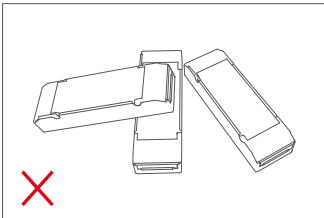

Please do not stack the products. The distance between two products should be $\geq 15\text{cm}$ so as not to affect heat dissipation and the lifespan of the products.

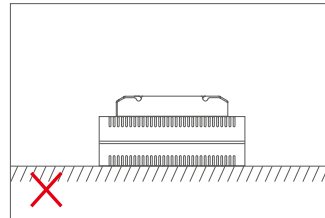
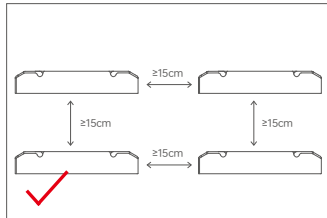

Please do not place the products on the floor. The distance between the product and the floor should be $\geq 100\text{cm}$ so as to avoid signal interference.

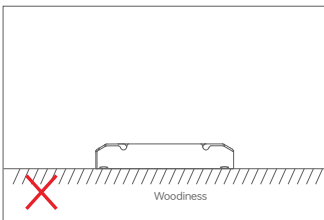
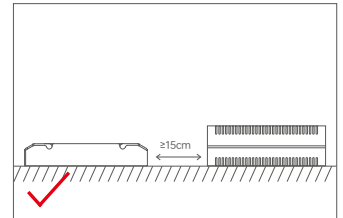

Do not fix the product tightly against the wooden board with screws. Please add a washer $\geq 7\text{mm}$ thick under the mounting screws to leave a gap for effective heat dissipation, so as to avoid affecting the heat dissipation and service life of the product.

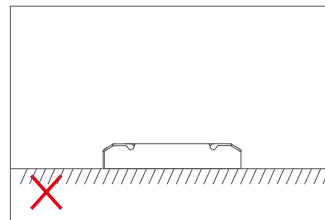
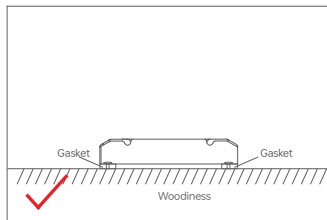

Please do not place the products on the floor. The distance between the product and the floor should be $\geq 100\text{cm}$ so as to avoid signal interference.

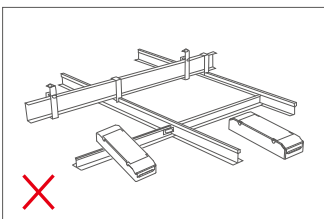
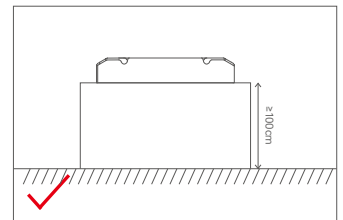

Do not allow the product to come into large-area contact with metal objects (e.g. keel frames). The separation distance shall be $\geq 15\text{cm}$ to avoid signal interference affecting operation.

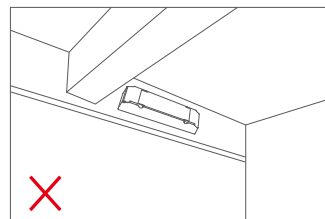
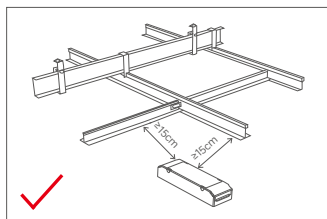

Please do not install the products on beams or near the corners. The distance between the product and the beam or the corner should be $\geq 15\text{cm}$ so as to avoid signal interference.

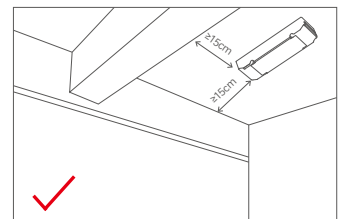

For use with P-series controllers

Key pairing code

1. Short press the ID learning button on the controller. The load indicator will flash. Please complete the following steps within 10 seconds.

2. Pairing the remote control:

Press and hold the ON button on the remote control for 2 seconds.

The remote control indicator light will flash rapidly three times and then turn off.

If the color temperature slider or color slider changes when touched, the learning process was successful.

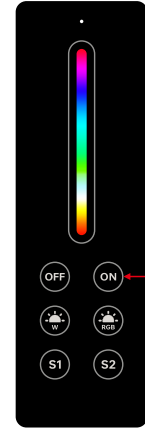

② Long press the ON key for 2 s

Power-on code pairing

1. After the controller has been powered off and then powered back on, please complete the following steps within 10 seconds.

2. Pairing the remote control:

Press and hold the ON button on the remote control for 2 seconds. The remote control's indicator light will flash rapidly three times and then turn off, and you will feel a change when touching the slider, indicating that the programming was successful.



Single-zone remote control

Note: A single controller can pair with up to 10pcs remote controls. If more than 10pcs remote controls are paired, the ID code of the first remote control will be automatically deleted.

Clear Code

To delete all remote controls:

Press and hold the controller ID learning button for 6 seconds. The controller load light will flash 4 times quickly and then stay on, indicating successful code clearing

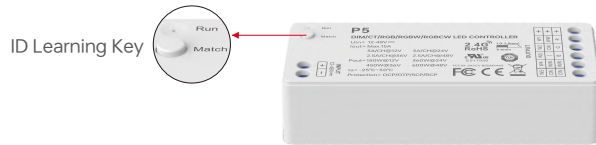

Use the Remote Controls Together

Code Pairing (assuming B learns from A)

1. Press and hold the ON and OFF buttons on the remote control simultaneously until the indicator light stays on, then release them.

2. Within 5 seconds, press any button on Remote A. The indicator light on Remote B will flash twice rapidly and then turn off, indicating that the pairing was successful.

*Assuming Remote Control A has already been paired with the controller, if you program Remote Control B to mimic Remote Control A, Remote Control B can be used to control the system directly without needing to be paired with the controller;

*Only remotes of the same model can be programmed to mimic each other.



A



B

Clear Code

Press and hold the S1 and S2 buttons on the B remote control simultaneously for about 10 seconds; when the indicator light flashes three times, the programmed remote control code will be cleared.



B

Transportation and Storage

1. Transportation

Products can be shipped via vehicles, boats and planes.

During transportation, products should be protected from rain and sun. Please avoid severe shock and vibration during the loading and unloading process.

2. Storage

The storage conditions should comply with the Class I Environmental Standards. The products that have been stored for more than six months are recommended to be re-inspected and can be used only after they have been qualified.

Attentions

- Please use in a dry indoor environment;
 - When installing the battery, please connect the positive and negative terminal correctly. If the remote will not be used for a long period, take the battery out;
 - When the remote distance is shorten and or the remote doesn't work frequently, please change the battery in time;
 - Please carefully take it and put it down to prevent falls that cause damage;
 - If a fault occurs, please do not attempt to fix products by yourself. If you have any question, please contact your suppliers.
- * This manual is subject to changes without further notice. Product functions depend on the goods. Please feel free to contact our official distributors if you have any question.

Warranty Agreement

- Warranty periods from the date of delivery: 5 years.
- Free repair or replacement services for quality problems are provided within warranty periods.

Warranty exclusions below:

Following conditions are not within the guarantee range of free repairing or replacementservices:

- Beyond warranty periods;
- Any artificial damage caused by high voltage, overload, or improper operations;
- Products with severe physical damage;
- Damage caused by natural disasters and force majeure;
- Warranty labels and barcodes have been damaged.
- No any contract signed by our company.

1. Repair or replacement provided is the only remedy for customers. Our company is not liable for any incidental or consequential damage unless it is within the law.

2. Our company has the right to amend or adjust the terms of this warranty, and release in written form shall prevail.

LED彩色控制器套装

- 控制器外壳采用科思创/三星PC阻燃V0级原料;
- 带软启动渐亮功能, 让人眼视觉更舒适;
- 遥控器采用流线型外观与磁吸设计, 使用两节7号电池供电;
- RF2.4G无线传输, 信号稳定、抗干扰能力强;
- 配备独立开/关按键, 可实现灯光一键快捷开关;
- 通过彩色触摸滑条快速调节颜色;
- W亮度与RGB亮度采用独立按键设计, 支持短按开关、长按调节, 操作直观便捷;
- 预置2个场景模式, 支持快捷调用, 同时可通过长按保存自定义场景;
- 一个遥控器可搭配多个控制器, 一个控制器可搭配多达10个遥控器;
- 支持控制器群组同步调光。



技术参数

C4遥控器

区域控制	单区
调光类型	RGBW
无线类型	RF 2.4GHz
供电	3Vdc, 2×AAA(7号) 注: 电池需另行选购
待机电流	< 5uA
工作温度	-25°C~50°C
产品重量	遥控器: 62g; 支架: 12g
规格尺寸	遥控器: L150 * W48 * H15.5mm; 支架: L85 * W35 * H20mm

P4 控制器

输入电压	12-48Vdc
输出电压	12-48Vdc
无线类型	RF 2.4GHz
通道数量	4通道
负载电流	Max. 15A
负载功率	180W@12V 288W@24V 360W@36V 480W@48V
工作温度	-25°C~50°C
保护	短路、过温、过流保护、防反接保护
产品重量	46g±5g
规格尺寸	L91×W37×H21(mm)



RoHS



结构尺寸

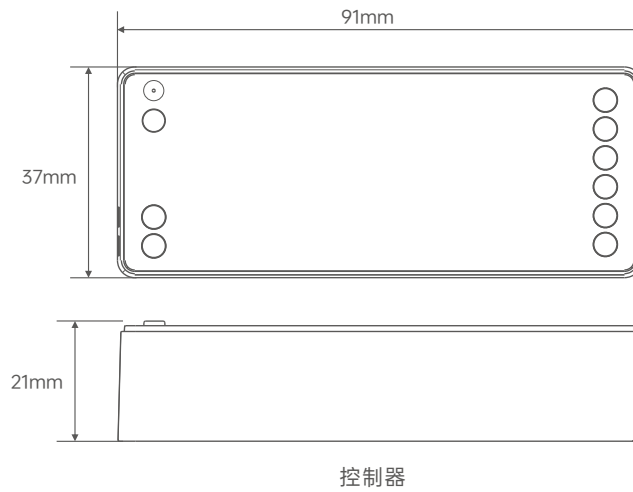
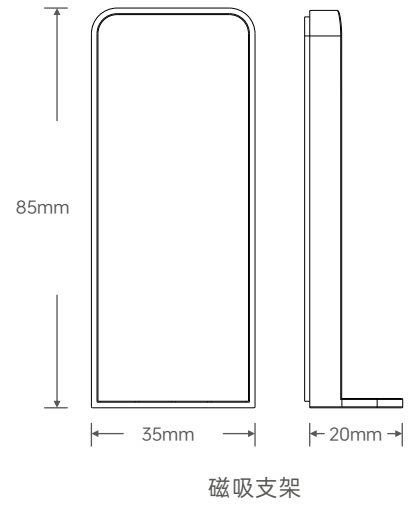
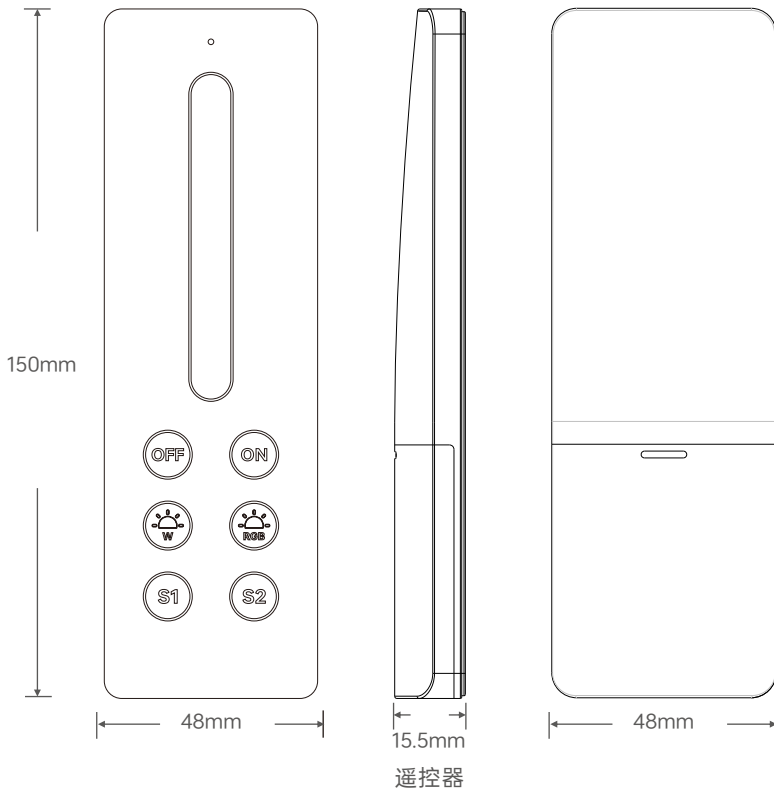

 产品: 41mm
  开孔尺寸: ϕ 43-45mm

产品安装

- ①打开遥控器电池仓，装入两枚AAA (7号)电池，注意正负极方向。
- ②撕开附赠双面胶保护膜，将磁吸支架粘贴于墙面并用力按压固定（静置24小时使其牢固贴合，再放置遥控器，防止脱落）。
- ③将遥控器吸附至磁吸支架上，完成安装。



功能描述

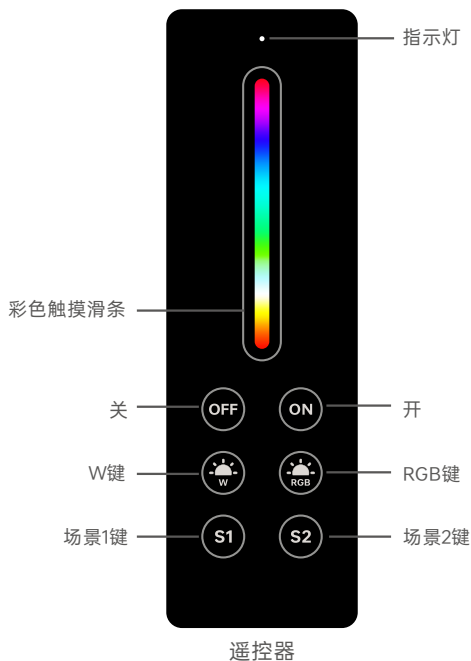

ON键: 短按开; 长按 2 秒进行配对。

OFF键: 短按关。

彩色触摸滑条: 触摸改变灯光的RGB 颜色。

W键: 短按开关W通道, 长按调节W亮度, 无极调光。

RGB键: 短按开关RGB通道, 长按调节RGB亮度, 无极调光。

场景键: 短按调用场景; 长按2秒将当前灯光状态保存到场景中且指示灯快闪红色2次。

指示灯: 彩色与亮度调节时, 指示灯同步变化。

注: ① 如果按下按键遥控器指示灯不亮, 即可能电池没电, 请及时更换电池。

② 6秒无按键操作, 遥控器将进入睡眠状态, 需按任意键退出睡眠状态。



接线示意图

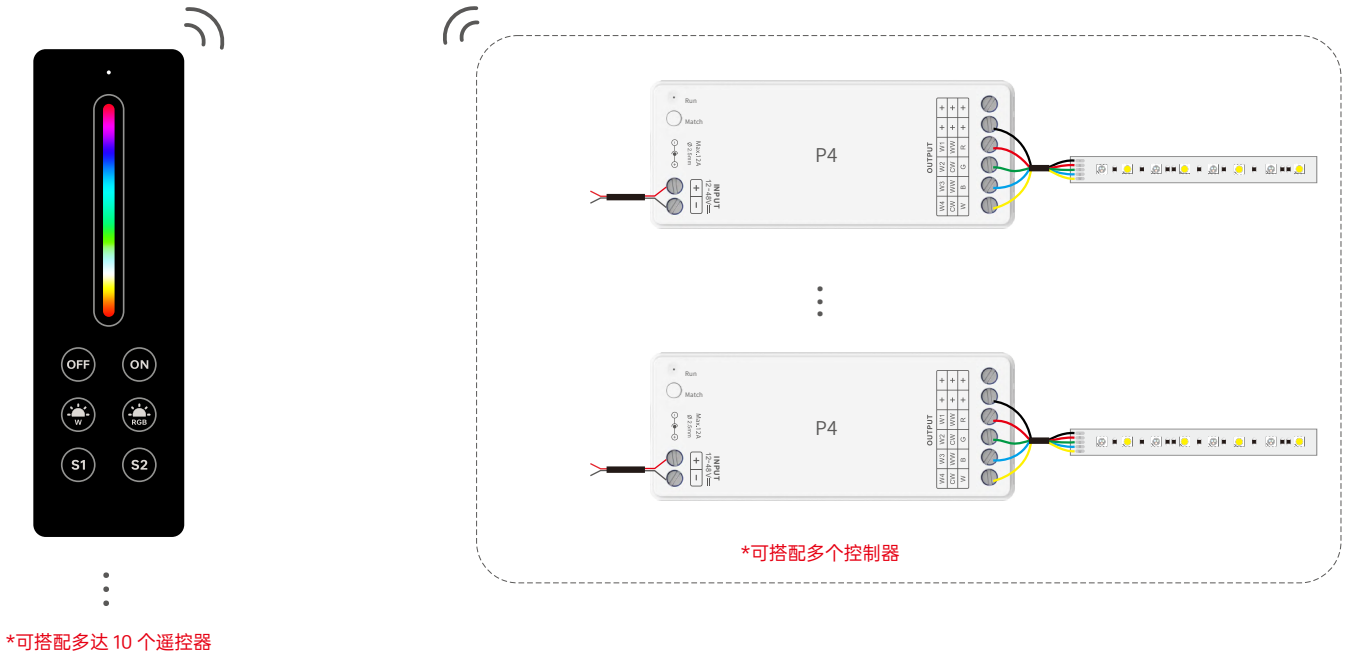

安装注意事项

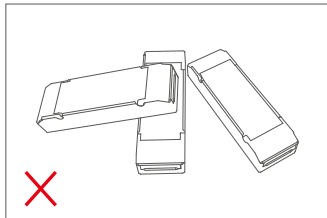

请勿将产品堆叠摆放，产品与产品间隔距离应 $\geq 15\text{cm}$ ，避免影响产品散热和使用寿命。

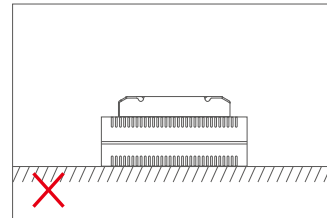
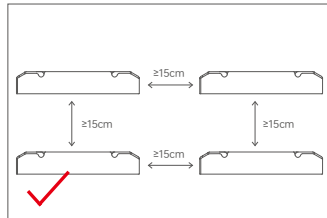

请勿将产品置于电源上方，产品与电源间隔距离应 $\geq 15\text{cm}$ ，避免影响产品散热而减少使用寿命。

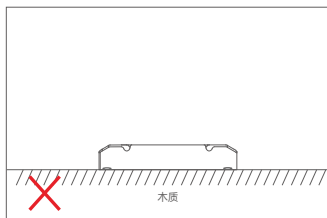
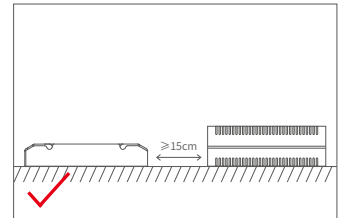

请勿将产品螺丝固定紧贴于木板，应在固定螺丝下增加 $\geq 7\text{mm}$ 的垫片，留点空隙可以有效散热，避免影响产品散热和使用寿命。

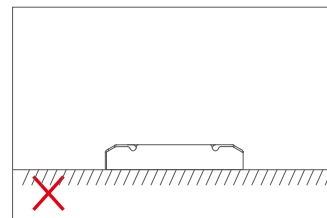
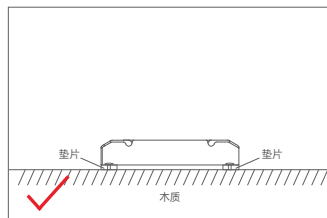

请勿将产品放置在地面上。产品与地面之间的距离应 $\geq 100\text{cm}$ ，以免信号干扰影响使用。

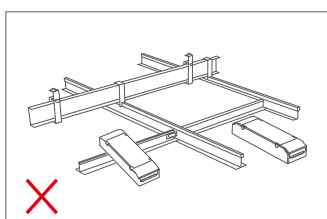
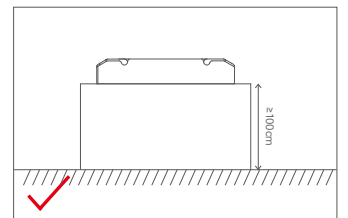

请勿将产品大面积接触金属物体(如：龙骨架)，间隔距离应 $\geq 15\text{cm}$ ，以免信号干扰影响使用。

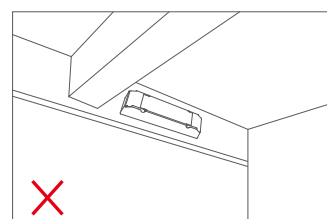
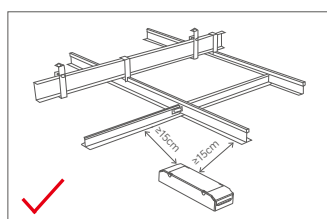

请勿将产品安装在横梁、墙角等位置，间隔距离应 $\geq 15\text{cm}$ ，以免信号干扰影响使用。

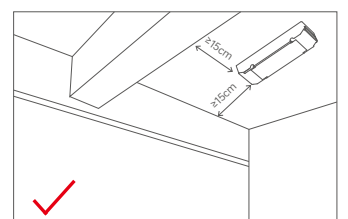

遥控器与控制器配对方法

按键对码

- 1.短按控制器的ID学习键，负载灯闪烁，请在10秒内完成以下操作。
- 2.对码遥控器：
长按遥控器ON键2秒，遥控器指示灯快闪3次后熄灭，且触摸彩色滑条有变化，即学习成功。

上电对码

1. 控制器断电后重新上电，请在10秒内完成以下操作。
- 2.对码遥控器：
长按遥控器ON键2秒，遥控器指示灯快闪3次后熄灭，且触摸彩色滑条有变化，即学习成功。



注：一台控制器最多可配对10个遥控器，配对超过10个遥控器将会自动删除最前面的遥控器ID码。

清码

- 删除全部遥控器方法：
长按控制器ID学习键6秒，控制器负载灯快闪4次后常亮，清码成功。



遥控器之间配对方法

对码 (假设B学习A)

- 1.同时按住遥控器的 ON、OFF键，直至指示灯常亮后松开。
- 2.在5秒内按下A遥控器的任意键，B遥控器指示灯快闪2次后熄灭，学习成功。

*假设A遥控器已经与控制器配对使用，再用B遥控器学习A遥控器，那B遥控器无需再与对应控制器配对便可直接控制使用；

*同型号遥控器才能互学。

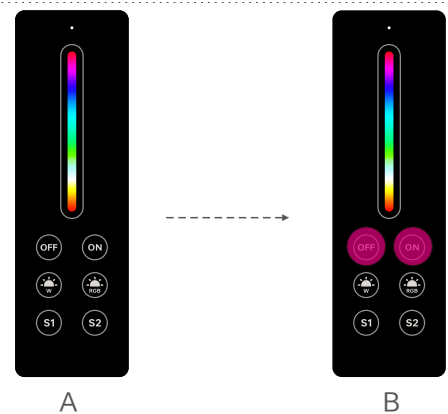

清码

同时长按B遥控器S1键和S2键约 10s，指示灯快闪 3 次即清除所学的遥控器码。



运输和贮存

1. 运输

产品适用车、船、飞机交通运输工具运输。

在运输中，应使用遮篷进行防雨和防晒，并保持文明装卸，不应有剧烈振动、撞击等。

2. 贮存

贮存符合I类环境的规定。贮存期限超过6个月的产品建议重新检验，合格后方可使用。

微功率设备使用说明

- (1) 本产品使用的 RF2.4GHz 技术符合“微功率短距离无线电发射设备目录和技术要求”的具体条款和使用场景，采用的天线类型和性能，控制、调整及开关等使用方法；
- (2) 不得擅自改变使用场景或使用条件、扩大发射频率范围、加大发射功率（包括额外加装射频功率放大器），不得擅自更改发射天线；
- (3) 不得对其他合法的无线电台（站）产生有害干扰，也不得提出免受有害干扰保护；
- (4) 应当承受辐射射频能量的工业、科学及医疗（ISM）应用设备的干扰或其他合法的无线电台（站）干扰；
- (5) 如对其他合法的无线电台（站）产生有害干扰时，应立即停止使用，并采取措施消除干扰后方可继续使用；
- (6) 在航空器内和依据法律法规、国家有关规定、标准划设的射电天文台、气象雷达站、卫星地球站（含测控、测距、接收、导航站）等军民用无线电台（站）、机场等的电磁环境保护区域内使用微功率设备，应当遵守电磁环境保护及相关行业主管部门的规定；
- (7) 禁止在以机场跑道中心点为圆心、半径5000米的区域内使用各类模型遥控器；
- (8) 微功率设备使用时运行的环境条件:运行温度为-25°C~50°C和额定电压为3Vdc。

注意事项

- 限室内与干燥环境使用；
 - 安装电池时，注意电池的正负极，长时间不使用遥控器，请取出电池；
 - 当遥控距离变小或遥控频繁失效时，请及时更换电池；
 - 应轻拿轻放，避免跌落造成损坏；
 - 如果发生故障，请勿私自维修；如果有疑问，请联系供应商。
- * 本说明书的内容如有变更，恕不另行通知。若内容与您使用的功能有所不同，则以实物为准。如有疑问，请与供应商联系。

保修条例

- 自出厂之日起保修服务期为5年。
- 在保修服务期内出现产品质量问题我司将给予免费修理或更换服务。

非保修条例：

属下列情况不在免费保修或更换服务范围之内：

- 已经超出保修服务期；
- 过高电压、超负载、操作不当等人为造成的损坏；
- 产品外形严重损坏或变形；
- 自然灾害以及人力不可抗拒原因造成的损坏；
- 产品保修标签和产品唯一条形码损坏；
- 无我司签订的合同或发票凭证。

1. 修理或更换是我司对客户唯一补救措施。我司不承担任何附带引起的损害赔偿，除非在适用法律范围之内。
2. 我司享有修正或调整本保修条款的权利，并以书面形式发布为准。

更新日志

版本	更改日期	更改内容	更改人
A0	20260414	正稿	黎海鹏